

EX-45032

RS-232/422/485 PCI-Express
Karte mit 2 x 9 Pin Anschluss

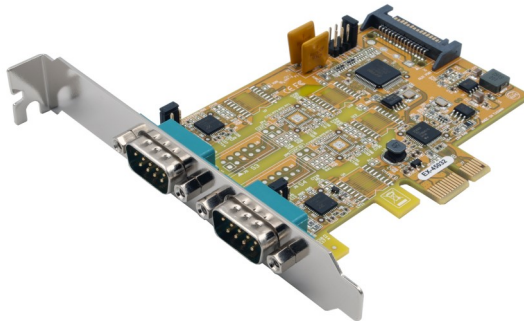

RS-232/422/485 PCI-Express
Card with 2 x 9 Pin Connector

Inhaltsverzeichnis

1. Beschreibung	3
2. Lieferumfang	3
3. Aufbau und Anschlüsse	4-5
3.1 Aufbau	4
3.2 Anschlüsse	4-5
4. Switch und Jumper Einstellungen	5-8
4.1 Switch Einstellungen	5-8
4.2 Jumper Einstellungen	8
5. Hardware Installation	9
6. Treiber Installation	9-11
7. Technische Daten	11



Index

1. Description	12
2. Extent of Delivery	12
3. Layout and Connections	13-14
3.1 Layout	13
3.2 Connections	13-14
4. Switch and Jumper Settings	14-17
4.1 Switch Settings	14-17
4.2 Jumper Settings	17
5. Hardware Installation	18
6. Driver Installation	18-20
7. Technical Information	20

1. Beschreibung

Die EX-45032 ist eine PCI-Express serielle RS-232/422/485 Karte mit 2 seriellen FIFO 16C95x Ports, für den Anschluss von High-Speed seriellen RS-232 Peripherie Geräten (z.B. Terminal, Modem, Plotter usw.). Der serielle PCI-Express Bus unterstützt dabei optimal die Leistung des schnellen FTDI Chipset mit 256byte FIFO Cache. Die EX-45032 gewährleistet so eine sichere Datenübertragung und exzellente Performance von bis zu 921KBaud/s für jedes angeschlossene Gerät! Sie unterstützt alle PCI-Express Slots von x1 bis x16. Es ist nicht möglich die I/O Adressen und Interrupts manuell einzustellen, da die Einstellungen der Karte vom System (BIOS) und beim installieren des Betriebssystems automatisch vorgenommen werden. Über die Jumper können Sie 5V oder 12V auf Pin 9 des seriellen Anschluss umleiten. Achten Sie bitte darauf dass die Angeschlossenen Geräte dies auch unterstützen. Die Ausgänge können voneinander unabhängig als RS-232, RS-422, RS-485 mit 2 Draht oder RS-485 mit 4 Draht konfiguriert werden.

Merkmale:

- PCI-Express x1 bis x16
- 300 Baud bis 921.6 KBAud
- RS-232, RS-422, 2 Draht RS-485 und 4 Draht RS-485
- Windows 200x/ XP/ Vista/ 7/ 8.x/ 10/ Server 20xx/ Linux/ Mac OS
- **Zertifiziert für** CE FCC  

2. Lieferumfang

Bevor Sie die EX-45032 in Ihren PC installieren, überprüfen Sie bitte zuerst den Inhalt der Lieferung:

- EX-45032
- Treiber CD
- Bedienungsanleitung

3. Aufbau und Anschlüsse

3.1 Aufbau

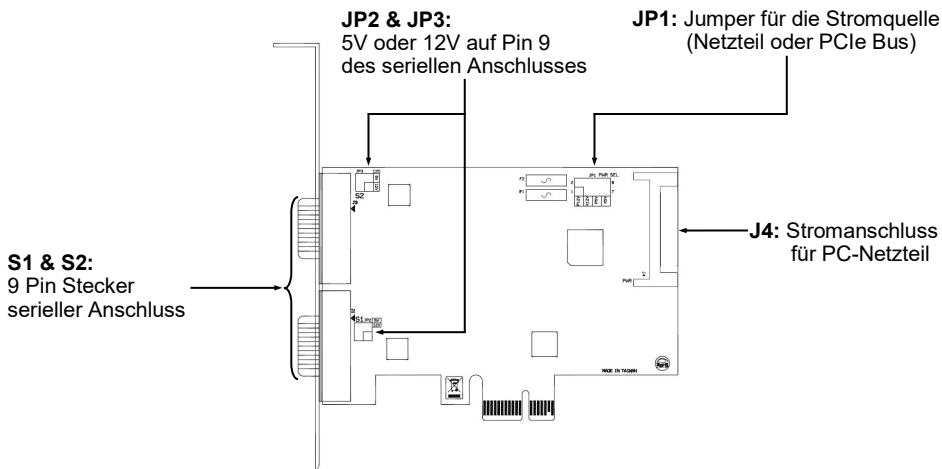

3.2 Anschlüsse

RS232 Pin Assignment

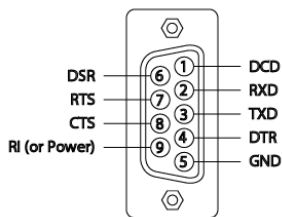

RS422 and RS485-4wire
Pin Assignment

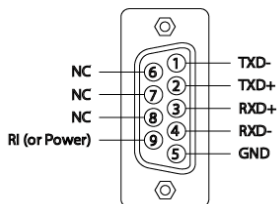

DB9 (EX-45032)

DB9 (Endgerät)

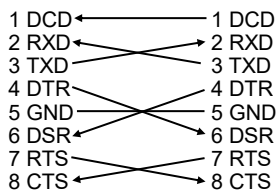

DB9 (EX-45032)

DB9 (Endgerät)

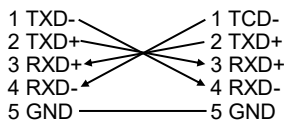

3. Aufbau und Anschlüsse

3.2 Anschlüsse

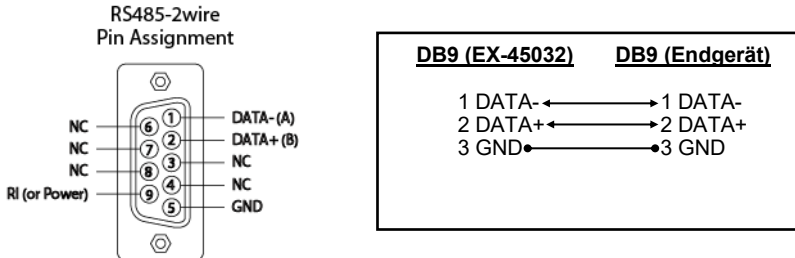

J4:



Pin	Bezeichnung	Pin	Bezeichnung	Pin	Bezeichnung
1	3.3 Volt (Orange)	7	5 Volt (pre-charge)	13	12 Volt (pre-charge)
2	3.3 Volt (Orange)	8	5 Volt (Rot)	14	12 Volt (Gelb)
3	3.3 Volt (pre-charge)	9	5 Volt (Rot)	15	12 Volt (Gelb)
4	Ground (Schwarz)	10	Ground (Schwarz)		
5	Ground (Schwarz)	11	Reserviert		
6	Ground (Schwarz)	12	Ground (Schwarz)		

Wenn der Jumper JP1 auf X5V oder X12V gesetzt ist, muss die Karte mit dem Stromanschluss vom PC Netzteil verbunden werden! Verwenden Sie dazu den Stromanschluss J4!

Bitte auf die richtige Polarität achten!

Achtung! Stecker nie bei eingeschaltetem PC ein oder ausstecken!

4. Switch und Jumper Einstellungen

4.1 Switch Einstellungen

Es gibt zwei 8-Pin DIP-Schalter auf der Rückseite der Platine der EX-45032. Für jeden Port gibt es einen separaten DIP-Schalter. Die 8-Pin DIP-Schalter sind für den Mode (RS-232, RS-422, RS-485 2-Draht oder RS-485 4-Draht) und die Terminierung der Signale RX+, RX-, TX+ und TX- zuständig (siehe Bild auf Seite 6). Die Einstellungen sind für jeden seriellen Port individuell einstellbar. Der DIP-Switch S1 ist für den Anschluss 1 zuständig und der zweite DIP-Switch S2 ist für den Anschluss 2 zuständig. Aus den nachfolgenden Abbildungen auf Seite 6, 7 und 8 können Sie die Einstellung des Mode Switch und der Terminator Switches entnehmen. Zusätzlich sind auf der Rückseite der Platine die Einstellmöglichkeiten des Mode und Terminator Switches aufgedruckt.

4. Switch und Jumper Einstellungen

4.1 Switch Einstellungen

Mode & Terminator Switch (S1 & S2_Mode)

Modes	RS-232	RS-422	RS-485 2-Draht	RS-485 4-Draht																																																																																																
Port 1	<table border="1"> <tr><td>M0</td><td>1</td><td>ON</td></tr> <tr><td>M1</td><td>2</td><td>■</td></tr> <tr><td>M2</td><td>3</td><td>■</td></tr> <tr><td>TERM</td><td>4</td><td>■</td></tr> <tr><td>T+</td><td>5</td><td>■</td></tr> <tr><td>T-</td><td>6</td><td>■</td></tr> <tr><td>R+</td><td>7</td><td>■</td></tr> <tr><td>R-</td><td>8</td><td>■</td></tr> </table>	M0	1	ON	M1	2	■	M2	3	■	TERM	4	■	T+	5	■	T-	6	■	R+	7	■	R-	8	■	<table border="1"> <tr><td>M0</td><td>1</td><td>ON</td></tr> <tr><td>M1</td><td>2</td><td>■</td></tr> <tr><td>M2</td><td>3</td><td>■</td></tr> <tr><td>TERM</td><td>4</td><td>■</td></tr> <tr><td>T+</td><td>5</td><td>■</td></tr> <tr><td>T-</td><td>6</td><td>■</td></tr> <tr><td>R+</td><td>7</td><td>■</td></tr> <tr><td>R-</td><td>8</td><td>■</td></tr> </table>	M0	1	ON	M1	2	■	M2	3	■	TERM	4	■	T+	5	■	T-	6	■	R+	7	■	R-	8	■	<table border="1"> <tr><td>M0</td><td>1</td><td>ON</td></tr> <tr><td>M1</td><td>2</td><td>■</td></tr> <tr><td>M2</td><td>3</td><td>■</td></tr> <tr><td>TERM</td><td>4</td><td>■</td></tr> <tr><td>T+</td><td>5</td><td>■</td></tr> <tr><td>T-</td><td>6</td><td>■</td></tr> <tr><td>R+</td><td>7</td><td>■</td></tr> <tr><td>R-</td><td>8</td><td>■</td></tr> </table>	M0	1	ON	M1	2	■	M2	3	■	TERM	4	■	T+	5	■	T-	6	■	R+	7	■	R-	8	■	<table border="1"> <tr><td>M0</td><td>1</td><td>ON</td></tr> <tr><td>M1</td><td>2</td><td>■</td></tr> <tr><td>M2</td><td>3</td><td>■</td></tr> <tr><td>TERM</td><td>4</td><td>■</td></tr> <tr><td>T+</td><td>5</td><td>■</td></tr> <tr><td>T-</td><td>6</td><td>■</td></tr> <tr><td>R+</td><td>7</td><td>■</td></tr> <tr><td>R-</td><td>8</td><td>■</td></tr> </table>	M0	1	ON	M1	2	■	M2	3	■	TERM	4	■	T+	5	■	T-	6	■	R+	7	■	R-	8	■
M0	1	ON																																																																																																		
M1	2	■																																																																																																		
M2	3	■																																																																																																		
TERM	4	■																																																																																																		
T+	5	■																																																																																																		
T-	6	■																																																																																																		
R+	7	■																																																																																																		
R-	8	■																																																																																																		
M0	1	ON																																																																																																		
M1	2	■																																																																																																		
M2	3	■																																																																																																		
TERM	4	■																																																																																																		
T+	5	■																																																																																																		
T-	6	■																																																																																																		
R+	7	■																																																																																																		
R-	8	■																																																																																																		
M0	1	ON																																																																																																		
M1	2	■																																																																																																		
M2	3	■																																																																																																		
TERM	4	■																																																																																																		
T+	5	■																																																																																																		
T-	6	■																																																																																																		
R+	7	■																																																																																																		
R-	8	■																																																																																																		
M0	1	ON																																																																																																		
M1	2	■																																																																																																		
M2	3	■																																																																																																		
TERM	4	■																																																																																																		
T+	5	■																																																																																																		
T-	6	■																																																																																																		
R+	7	■																																																																																																		
R-	8	■																																																																																																		
Port 2	<table border="1"> <tr><td>M0</td><td>1</td><td>ON</td></tr> <tr><td>M1</td><td>2</td><td>■</td></tr> <tr><td>M2</td><td>3</td><td>■</td></tr> <tr><td>TERM</td><td>4</td><td>■</td></tr> <tr><td>T+</td><td>5</td><td>■</td></tr> <tr><td>T-</td><td>6</td><td>■</td></tr> <tr><td>R+</td><td>7</td><td>■</td></tr> <tr><td>R-</td><td>8</td><td>■</td></tr> </table>	M0	1	ON	M1	2	■	M2	3	■	TERM	4	■	T+	5	■	T-	6	■	R+	7	■	R-	8	■	<table border="1"> <tr><td>M0</td><td>1</td><td>ON</td></tr> <tr><td>M1</td><td>2</td><td>■</td></tr> <tr><td>M2</td><td>3</td><td>■</td></tr> <tr><td>TERM</td><td>4</td><td>■</td></tr> <tr><td>T+</td><td>5</td><td>■</td></tr> <tr><td>T-</td><td>6</td><td>■</td></tr> <tr><td>R+</td><td>7</td><td>■</td></tr> <tr><td>R-</td><td>8</td><td>■</td></tr> </table>	M0	1	ON	M1	2	■	M2	3	■	TERM	4	■	T+	5	■	T-	6	■	R+	7	■	R-	8	■	<table border="1"> <tr><td>M0</td><td>1</td><td>ON</td></tr> <tr><td>M1</td><td>2</td><td>■</td></tr> <tr><td>M2</td><td>3</td><td>■</td></tr> <tr><td>TERM</td><td>4</td><td>■</td></tr> <tr><td>T+</td><td>5</td><td>■</td></tr> <tr><td>T-</td><td>6</td><td>■</td></tr> <tr><td>R+</td><td>7</td><td>■</td></tr> <tr><td>R-</td><td>8</td><td>■</td></tr> </table>	M0	1	ON	M1	2	■	M2	3	■	TERM	4	■	T+	5	■	T-	6	■	R+	7	■	R-	8	■	<table border="1"> <tr><td>M0</td><td>1</td><td>ON</td></tr> <tr><td>M1</td><td>2</td><td>■</td></tr> <tr><td>M2</td><td>3</td><td>■</td></tr> <tr><td>TERM</td><td>4</td><td>■</td></tr> <tr><td>T+</td><td>5</td><td>■</td></tr> <tr><td>T-</td><td>6</td><td>■</td></tr> <tr><td>R+</td><td>7</td><td>■</td></tr> <tr><td>R-</td><td>8</td><td>■</td></tr> </table>	M0	1	ON	M1	2	■	M2	3	■	TERM	4	■	T+	5	■	T-	6	■	R+	7	■	R-	8	■
M0	1	ON																																																																																																		
M1	2	■																																																																																																		
M2	3	■																																																																																																		
TERM	4	■																																																																																																		
T+	5	■																																																																																																		
T-	6	■																																																																																																		
R+	7	■																																																																																																		
R-	8	■																																																																																																		
M0	1	ON																																																																																																		
M1	2	■																																																																																																		
M2	3	■																																																																																																		
TERM	4	■																																																																																																		
T+	5	■																																																																																																		
T-	6	■																																																																																																		
R+	7	■																																																																																																		
R-	8	■																																																																																																		
M0	1	ON																																																																																																		
M1	2	■																																																																																																		
M2	3	■																																																																																																		
TERM	4	■																																																																																																		
T+	5	■																																																																																																		
T-	6	■																																																																																																		
R+	7	■																																																																																																		
R-	8	■																																																																																																		
M0	1	ON																																																																																																		
M1	2	■																																																																																																		
M2	3	■																																																																																																		
TERM	4	■																																																																																																		
T+	5	■																																																																																																		
T-	6	■																																																																																																		
R+	7	■																																																																																																		
R-	8	■																																																																																																		

Resistoren Off

M0	1	ON
M1	2	■
M2	3	■
TERM	4	■
T+	5	■
T-	6	■
R+	7	■
R-	8	■

Resistoren On

M0	1	ON
M1	2	■
M2	3	■
TERM	4	■
T+	5	■
T-	6	■
R+	7	■
R-	8	■

Terminator Off

M0	1	ON
M1	2	■
M2	3	■
TERM	4	■
T+	5	■
T-	6	■
R+	7	■
R-	8	■

Terminator On

M0	1	ON
M1	2	■
M2	3	■
TERM	4	■
T+	5	■
T-	6	■
R+	7	■
R-	8	■

4. Switch und Jumper Einstellungen

4.1 Switch Einstellungen

Resistoren für RS-422, RS-485 2-Draht und RS-485 4-Draht Mode:

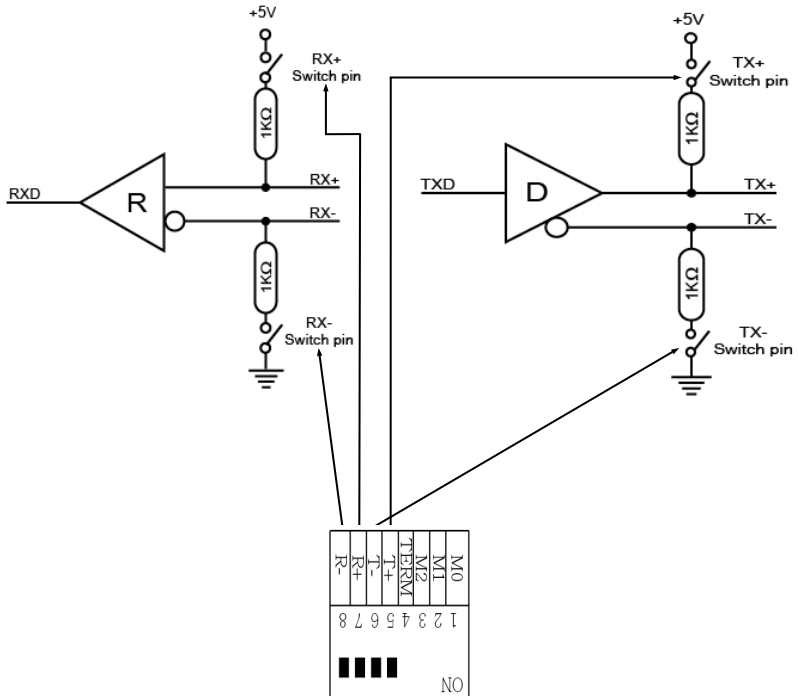

4. Switch und Jumper Einstellungen

4.1 Switch Einstellungen

Terminator für RS-422, RS-485 2-Draht und RS-485 4-Draht Mode:

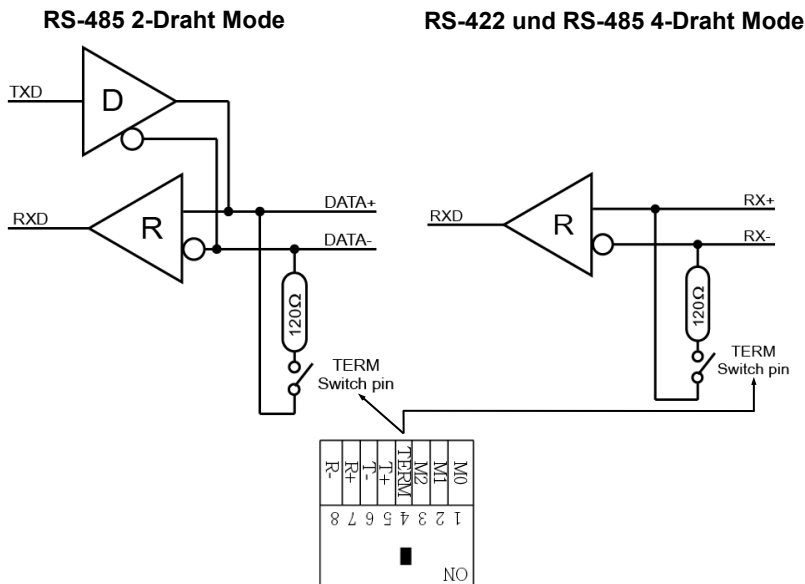

4.2 Jumper Einstellungen

JP2 & JP3:



- 5V** = Am Pin 9 liegt jetzt eine Spannung von +5V DC an. (Werkseinstellung)
- 12V** = Am Pin 9 liegt jetzt eine Spannung von +12V DC an.

Es gibt den Jumper zwei Mal auf der Platine, sodass Sie für alle seriellen Ports die Einstellung individuell vornehmen können. Die Einstellung der Spannung nehmen Sie mit JP1 vor. Dieser sollte aber bei Standard Anwendungen nicht verstellt werden.

JP1:

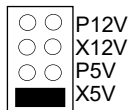

Wenn Sie einen der Jumper JP2 & JP3 auf 5V oder 12V gesetzt haben, können Sie mit dem Jumper JP1 den Spannungswert einstellen. Es gibt 4 verschiedene Spannungsquellen. **(Achtung!** Anschluss J4 muss mit dem PC-Netzteil verbunden sein!)

- X5V** = 5Volt vom PC-Netzteil (Werkseinstellung)
- P5V** = 5Volt vom Mainboard
- X12V** = 12Volt vom PC-Netzteil
- P12V** = 12Volt vom Mainboard

5. Hardware Installation

Wenn Sie die Karte installieren, beachten Sie bitte die folgenden Hinweise. Da es große Unterschiede zwischen PC's gibt, können wir Ihnen nur eine generelle Anleitung zum Einbau der EX-45032 geben. Bei Unklarheiten halten Sie sich bitte an die Bedienungsanleitung Ihres Computersystems.

1. Schalten Sie Ihren Rechner und alle angeschlossenen Peripheriegeräte aus und ziehen Sie bei allen Geräten den Netzstecker.
2. Lösen Sie die Schrauben des Gehäuses auf der Rückseite Ihres Computers und entfernen Sie vorsichtig das Gehäuse.
3. Suchen Sie einen freien PCI-Express Steckplatz und stecken Sie die Karte vorsichtig in den ausgewählten PCI-Express Steckplatz ein. Stellen Sie sicher das es sich um den richtigen Steckplatz handelt!
4. Beachten Sie das die Karte korrekt eingesteckt wird und das kein Kurzschluss entsteht. Wenden Sie bitte keine Gewalt an um die Karte einzustecken!
5. Installieren Sie nun die externe Stromversorgung zur Entlastung des Mainboards und bei ggf. ausgewählter Stromquelle. (siehe Anschlüsse J4)
6. Danach befestigen Sie die Karte bitte mit einer Schraube am Gehäuse.
7. Jetzt können Sie das Computergehäuse mit den Schrauben wieder schließen.

6. Treiber Installation

Windows

Nach Abschluss der Hardwareinstallation erkennt das Betriebssystem automatisch die Karte und installiert diese! Falls die Treiber nicht automatisch installiert werden sollten, müssen Sie nun manuell zwei Treiber installieren. Zum einen den USB Host Treiber und zum anderen den USB zu seriell Treiber. Legen Sie hierfür die Treiber CD in Ihr CD-ROM Laufwerk (z.B. Laufwerk D:) ein und starten Sie das „**SETUP**“ welches sich im Ordner „uPD720201_202“ befindet (siehe Abbildung): Folgen Sie den Installationsanweisungen und schließen Sie die Installation ab. **Wichtig!** Starten Sie Ihren PC nach der Installation neu.

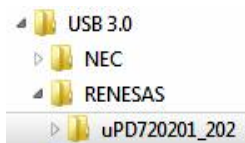

6. Treiber Installation

Windows

Als zweites installieren Sie jetzt den USB zu seriell Treiber. Nun öffnen Sie den Ordner „USB_to_IO/FTDI“. Nun wählen Sie den Ordner Ihres Betriebssystems aus und installieren Sie die Treiber (siehe Abbildung). Folgen Sie den Installationsanweisungen und schließen Sie die Installation ab. **Wichtig!** Starten Sie Ihren PC nach der Installation neu.

Es werden folgende Treiber für die Server Betriebssysteme installiert:

Windows Server 2003	=	XP Treiber
Windows Server 2008	=	VISTA Treiber
Windows Server 2008R2	=	Windows 7 Treiber
Windows Server 2012	=	Windows 8.x Treiber
Windows Server 2012R2	=	Windows 10 Treiber

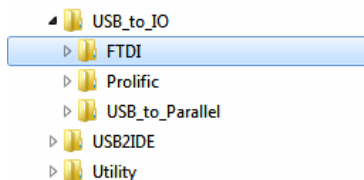

ÜBERPRÜFEN DES INSTALLIERTEN TREIBER

Öffnen Sie den >Geräte-Manager<. Jetzt müssten Sie unter „Anschlüsse (COM & LPT)“ und unter „USB-Controller“ folgende Einträge sehen:



Sind diese oder ähnliche Einträge vorhanden, ist die Karte richtig installiert.

ÄNDERN DER PORT NUMMER

Sie können auch die Port Nummer ändern, indem Sie im Gerätemanager z.B. „COM3“ „Anschlusseinstellung“ und „Erweitert“ öffnen. Nun können Sie dann zwischen COM3 bis COM256 wählen!

6. Treiber Installation

Linux & Mac OS

Die Treiber für Linux & Mac OS Systeme befinden sich ebenfalls im Ordner „USB_to_IO/FTDI“. Nun wählen Sie den Ordner Ihres Betriebssystems aus und installieren Sie die Treiber (siehe Abbildung).

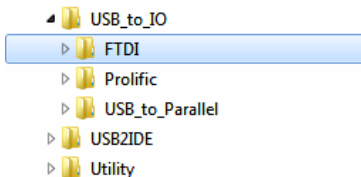

Da sich die einzelnen Distributionen und Kernelversionen sehr voneinander unterscheiden, können wir Ihnen leider keine Installationsanweisung zu Verfügung stellen. Bitte halten Sie sich an die Installationsanweisung für Standard I/O Ports Ihrer Linux/Unix oder Mac OS Version. In einigen neueren Versionen, wird die Karte sogar automatisch beim Start installiert.



7. Technische Daten

Chip-Set:	FTDI
Datentransfer-Rate:	300 Baud bis 921.6 Kbaud
Anschlüsse:	2x 9 Pin seriell RS-232 Stecker, 1x SATA Stromanschluss
Hardwaresystem:	PCI-Express x1 bis x16
Betriebssystem:	Windows 200x/ XP/ Vista/ 7/ 8.x/ 10/ Server 200xx Linux/ Mac OS
Betriebstemperatur:	0° bis 55° Celsius
Lagertemperatur:	-40° bis 75° Celsius
Rel. Luftfeuchtigkeit:	5% bis 95%
Stromversorgung:	5V oder 12V über PCI-Express Slot oder SATA Stromanschluss
Abmessung:	112,30 x 120,00 mm
Gewicht:	200g

1. Description

The EX-45032 is a plug & play high-speed serial RS-232/422/485 expansion card for the PCI-Express bus. The EX-45032 provides two 9 pin high speed RS-232/422/485 serial ports. It uses data transfer rates up to 921Kbaud/s. The EX-45032 design utilizes the FTDI chipset with 256-byte buffer, which incorporates the latest in high speed interface technology. In combination with the fast PCI-Express bus it provides a secure and very high data transfer on each port. It supports all PCI-Express slots x1 to x16. It is not possible to change the address or IRQ settings manually, they will be obtained automatically by the system BIOS and operating system. With the jumpers you can enable 5V or 12V power to pin 9. Please note if you use power to pin 9 your peripheral device must support it. The serial ports can be configured as RS-232, RS-422, RS-485 2-wire or RS-485 4-wire.

Features:

- PCI-Express x1 to x16
- 300 Baud up to 921.6 KBaud
- RS-232, RS-422, RS-485 2-wire and RS-485 4-wire
- Windows 200x/ XP/ Vista/ 7/ 8.x/ 10/ Server 20xx/ Linux/ Mac OS
- **Certificate for**    

2. Extent of Delivery

Before you install the EX-45032 in your PC, you should first check the contents of the delivery:

- EX-45032
- Driver CD
- Manual

3. Layout and Connections

3.1 Layout

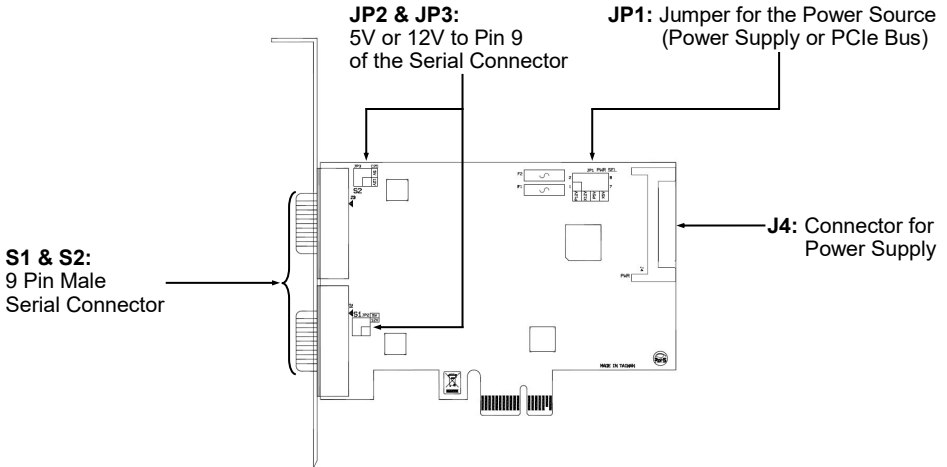

3.2 Connections

RS232 Pin Assignment

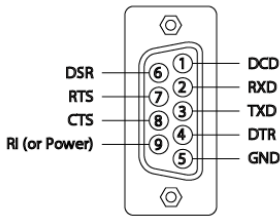

RS422 and RS485-4wire Pin Assignment

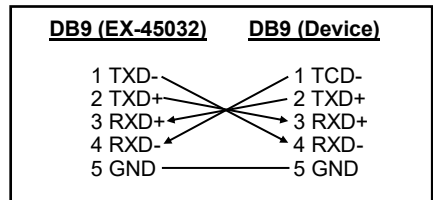
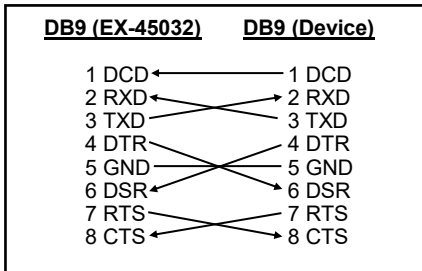
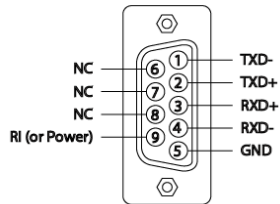

3. Layout and Connections

3.2 Connections

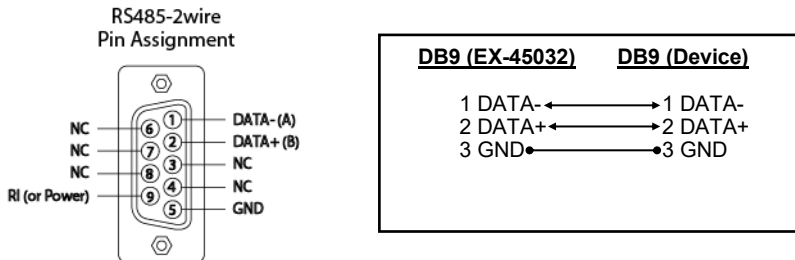

J4:



Pin	Assignment	Pin	Assignment	Pin	Assignment
1	3.3 Volt (Orange)	7	5 Volt (pre-charge)	13	12 Volt (pre-charge)
2	3.3 Volt (Orange)	8	5 Volt (Red)	14	12 Volt (Yellow)
3	3.3 Volt (pre-charge)	9	5 Volt (Red)	15	12 Volt (Yellow)
4	Ground (Black)	10	Ground (Black)		
5	Ground (Black)	11	Reserved		
6	Ground (Black)	12	Ground (Black)		

If jumper JP1 is set to X5V or X12V, you must connect the card with the PC power supply. It must be connected on the power connector J4!

Please make sure you connect the plug in the right direction!

Attention! Never connect or release the plug while the PC is supplied with power!

4. Switch and Jumper Settings

4.1 Switch Settings

There are two 8-pin DIP-switches on the backside of the board at the EX-45032. For each port there is a separate DIP-switch. The 8-pin DIP-switches are for the modes (RS-232, RS-422, RS-485 2-wire or RS-485 4-wire) and for the signal termination for RX+, RX-, TX+ and TX- (see picture on page 15). The settings can be set individually for each serial port. The DIP-switch are responsible for the port 1 (S1) and the second DIP-switch are responsible for the port 2 (S2). The following images on page 15, 16 and 17 you can see the setting of the mode switch and terminator switch. Additionally the setting of the mode switch are printed on the back of the board.

4. Switch and Jumper Settings

4.1 Switch Settings

Mode & Terminator Switch (S1 & S2_Mode)

Modes	RS-232	RS-422	RS-485 2-wire	RS-485 4-wire																																																																																																
Port 1	<table border="1"> <tr><td>M0</td><td>1</td><td>ON</td></tr> <tr><td>M1</td><td>2</td><td>■</td></tr> <tr><td>M2</td><td>3</td><td>■</td></tr> <tr><td>TERM</td><td>4</td><td>■</td></tr> <tr><td>T+</td><td>5</td><td>■</td></tr> <tr><td>T-</td><td>6</td><td>■</td></tr> <tr><td>R+</td><td>7</td><td>■</td></tr> <tr><td>R-</td><td>8</td><td>■</td></tr> </table>	M0	1	ON	M1	2	■	M2	3	■	TERM	4	■	T+	5	■	T-	6	■	R+	7	■	R-	8	■	<table border="1"> <tr><td>M0</td><td>1</td><td>ON</td></tr> <tr><td>M1</td><td>2</td><td>■</td></tr> <tr><td>M2</td><td>3</td><td>■</td></tr> <tr><td>TERM</td><td>4</td><td>■</td></tr> <tr><td>T+</td><td>5</td><td>■</td></tr> <tr><td>T-</td><td>6</td><td>■</td></tr> <tr><td>R+</td><td>7</td><td>■</td></tr> <tr><td>R-</td><td>8</td><td>■</td></tr> </table>	M0	1	ON	M1	2	■	M2	3	■	TERM	4	■	T+	5	■	T-	6	■	R+	7	■	R-	8	■	<table border="1"> <tr><td>M0</td><td>1</td><td>ON</td></tr> <tr><td>M1</td><td>2</td><td>■</td></tr> <tr><td>M2</td><td>3</td><td>■</td></tr> <tr><td>TERM</td><td>4</td><td>■</td></tr> <tr><td>T+</td><td>5</td><td>■</td></tr> <tr><td>T-</td><td>6</td><td>■</td></tr> <tr><td>R+</td><td>7</td><td>■</td></tr> <tr><td>R-</td><td>8</td><td>■</td></tr> </table>	M0	1	ON	M1	2	■	M2	3	■	TERM	4	■	T+	5	■	T-	6	■	R+	7	■	R-	8	■	<table border="1"> <tr><td>M0</td><td>1</td><td>ON</td></tr> <tr><td>M1</td><td>2</td><td>■</td></tr> <tr><td>M2</td><td>3</td><td>■</td></tr> <tr><td>TERM</td><td>4</td><td>■</td></tr> <tr><td>T+</td><td>5</td><td>■</td></tr> <tr><td>T-</td><td>6</td><td>■</td></tr> <tr><td>R+</td><td>7</td><td>■</td></tr> <tr><td>R-</td><td>8</td><td>■</td></tr> </table>	M0	1	ON	M1	2	■	M2	3	■	TERM	4	■	T+	5	■	T-	6	■	R+	7	■	R-	8	■
M0	1	ON																																																																																																		
M1	2	■																																																																																																		
M2	3	■																																																																																																		
TERM	4	■																																																																																																		
T+	5	■																																																																																																		
T-	6	■																																																																																																		
R+	7	■																																																																																																		
R-	8	■																																																																																																		
M0	1	ON																																																																																																		
M1	2	■																																																																																																		
M2	3	■																																																																																																		
TERM	4	■																																																																																																		
T+	5	■																																																																																																		
T-	6	■																																																																																																		
R+	7	■																																																																																																		
R-	8	■																																																																																																		
M0	1	ON																																																																																																		
M1	2	■																																																																																																		
M2	3	■																																																																																																		
TERM	4	■																																																																																																		
T+	5	■																																																																																																		
T-	6	■																																																																																																		
R+	7	■																																																																																																		
R-	8	■																																																																																																		
M0	1	ON																																																																																																		
M1	2	■																																																																																																		
M2	3	■																																																																																																		
TERM	4	■																																																																																																		
T+	5	■																																																																																																		
T-	6	■																																																																																																		
R+	7	■																																																																																																		
R-	8	■																																																																																																		
Port 2	<table border="1"> <tr><td>M0</td><td>1</td><td>ON</td></tr> <tr><td>M1</td><td>2</td><td>■</td></tr> <tr><td>M2</td><td>3</td><td>■</td></tr> <tr><td>TERM</td><td>4</td><td>■</td></tr> <tr><td>T+</td><td>5</td><td>■</td></tr> <tr><td>T-</td><td>6</td><td>■</td></tr> <tr><td>R+</td><td>7</td><td>■</td></tr> <tr><td>R-</td><td>8</td><td>■</td></tr> </table>	M0	1	ON	M1	2	■	M2	3	■	TERM	4	■	T+	5	■	T-	6	■	R+	7	■	R-	8	■	<table border="1"> <tr><td>M0</td><td>1</td><td>ON</td></tr> <tr><td>M1</td><td>2</td><td>■</td></tr> <tr><td>M2</td><td>3</td><td>■</td></tr> <tr><td>TERM</td><td>4</td><td>■</td></tr> <tr><td>T+</td><td>5</td><td>■</td></tr> <tr><td>T-</td><td>6</td><td>■</td></tr> <tr><td>R+</td><td>7</td><td>■</td></tr> <tr><td>R-</td><td>8</td><td>■</td></tr> </table>	M0	1	ON	M1	2	■	M2	3	■	TERM	4	■	T+	5	■	T-	6	■	R+	7	■	R-	8	■	<table border="1"> <tr><td>M0</td><td>1</td><td>ON</td></tr> <tr><td>M1</td><td>2</td><td>■</td></tr> <tr><td>M2</td><td>3</td><td>■</td></tr> <tr><td>TERM</td><td>4</td><td>■</td></tr> <tr><td>T+</td><td>5</td><td>■</td></tr> <tr><td>T-</td><td>6</td><td>■</td></tr> <tr><td>R+</td><td>7</td><td>■</td></tr> <tr><td>R-</td><td>8</td><td>■</td></tr> </table>	M0	1	ON	M1	2	■	M2	3	■	TERM	4	■	T+	5	■	T-	6	■	R+	7	■	R-	8	■	<table border="1"> <tr><td>M0</td><td>1</td><td>ON</td></tr> <tr><td>M1</td><td>2</td><td>■</td></tr> <tr><td>M2</td><td>3</td><td>■</td></tr> <tr><td>TERM</td><td>4</td><td>■</td></tr> <tr><td>T+</td><td>5</td><td>■</td></tr> <tr><td>T-</td><td>6</td><td>■</td></tr> <tr><td>R+</td><td>7</td><td>■</td></tr> <tr><td>R-</td><td>8</td><td>■</td></tr> </table>	M0	1	ON	M1	2	■	M2	3	■	TERM	4	■	T+	5	■	T-	6	■	R+	7	■	R-	8	■
M0	1	ON																																																																																																		
M1	2	■																																																																																																		
M2	3	■																																																																																																		
TERM	4	■																																																																																																		
T+	5	■																																																																																																		
T-	6	■																																																																																																		
R+	7	■																																																																																																		
R-	8	■																																																																																																		
M0	1	ON																																																																																																		
M1	2	■																																																																																																		
M2	3	■																																																																																																		
TERM	4	■																																																																																																		
T+	5	■																																																																																																		
T-	6	■																																																																																																		
R+	7	■																																																																																																		
R-	8	■																																																																																																		
M0	1	ON																																																																																																		
M1	2	■																																																																																																		
M2	3	■																																																																																																		
TERM	4	■																																																																																																		
T+	5	■																																																																																																		
T-	6	■																																																																																																		
R+	7	■																																																																																																		
R-	8	■																																																																																																		
M0	1	ON																																																																																																		
M1	2	■																																																																																																		
M2	3	■																																																																																																		
TERM	4	■																																																																																																		
T+	5	■																																																																																																		
T-	6	■																																																																																																		
R+	7	■																																																																																																		
R-	8	■																																																																																																		

Resistor Off

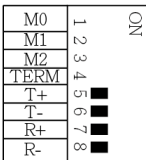

Resistor On

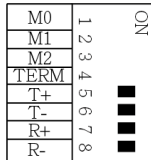

Terminator Off

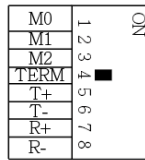

Terminator On

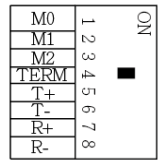

4. Switch and Jumper Settings

4.1 Switch Settings

Resistors for RS-422, RS-485 2-wire and RS-485 4-wire mode:

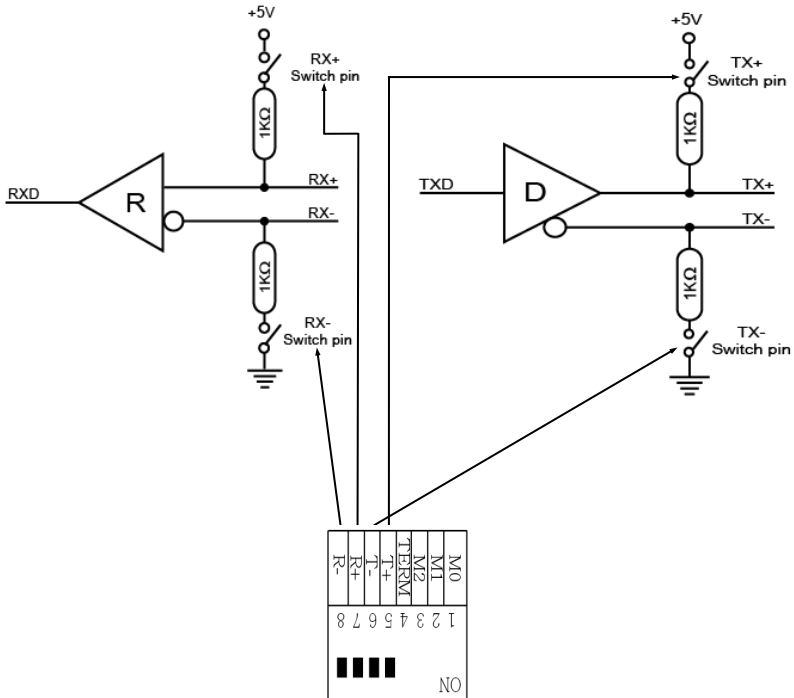

4. Switch and Jumper Settings

4.1 Switch Settings

Termination for RS-422, RS-485 2-wire and RS-485 4-wire mode:

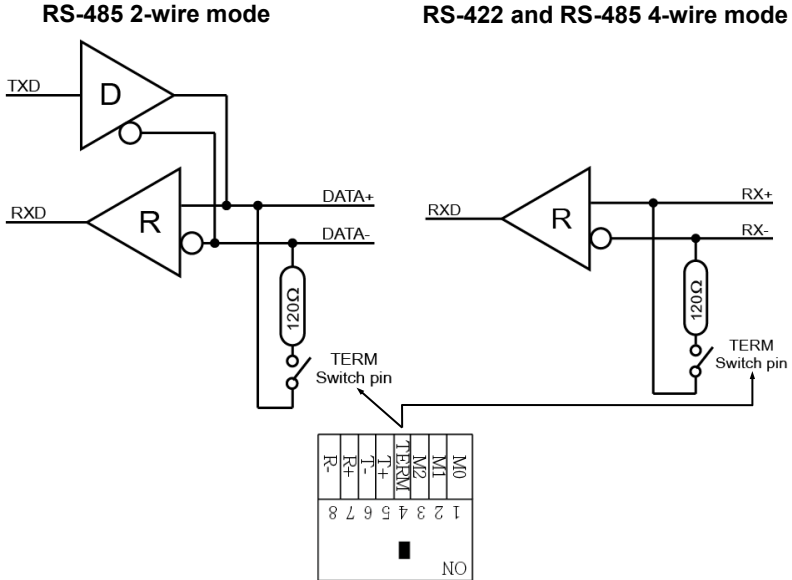

4.2 Jumper Settings

JP2 & JP3:



- 5V** = At pin 9 is now a voltage of +5V DC. (Factory Setting)
- 12V** = At pin 9 is now a voltage of +12V DC.

There are two jumper on the board, so you can make the settings individually for all serial ports. The voltage adjustment can be made with the jumper JP1. But this should not be adjusted for standard applications.

JP1:

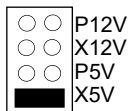

- If you have the jumper JP2 & JP3 set to 5V or 12V, you can adjust the voltage with the jumper JP1. There are 4 different power sources. **(Attention! Connector J4 must be connected to the power supply!)**
- X5V** = 5Volt from PC Power Supply (Factory Setting)
 - P5V** = 5Volt from Mainboard
 - X12V** = 12Volt from PC Power Supply
 - P12V** = 12Volt from Mainboard

5. Hardware Installation

If you are ready with the jumper settings, please proceed with the following installation instructions. Because there are large differences between PC's, we can give you only a general installation guide for the EX-45032. Please refer to your computer's reference manual whenever in doubt.

1. Turn off the power to your computer and any other connected peripherals.
2. Remove the mounting screws located at the rear and/or sides panels of your Computer and gently slide the cover off.
3. Locate an available expansion slot and remove its covers from the rear panel of your computer. Make sure it is the right expansion slot for the card (see card description)
4. Align the card with the PCI-Express slot and then gently but firmly, insert the card. Make sure the card is seated and oriented correctly. Never insert the card by force!
5. Now install the external power supply to relieve the mainboard and with the power source selected if necessary. (see connections J4)
6. Then connect the card with a screw to the rear panel of the computer case.
7. Gently replace your computer's cover and the mounting screws.

6. Driver Installation

Windows

After completing the hardware installation, the operating system will automatically the card and install this! If the driver should not be installed automatically, you must manually install two drivers. One ist the USB host driver and the other is the USB to serial driver. for this insert the driver CD into you CD-ROM drive (eg drive D:) and then start the „**SETUP**“ which is located in folder „uPD720201_202“ (see picture): Follow the hardware assistant and finish the installation. **Important!** Restart your PC in any case after installing the drivers.

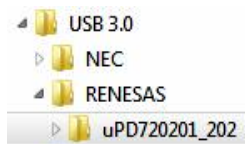

6. Driver Installation

Windows

Second, please install now the USB to serial driver. Open the folder „USB_to_IO/FTDI“. Please select the folder with your operating system and install the driver (see Picture). Follow the hardware assistant and finish the installation. **Important!** Restart your PC in any case after installing the drivers.

Use the following driver for the following Windows Server Version:

Windows Server 2003	=	XP Driver
Windows Server 2008	=	VISTA Driver
Windows Server 2008R2	=	Windows 7 Driver
Windows Server 2012	=	Windows 8.x Driver
Windows Server 2012R2	=	Windows 10 Driver

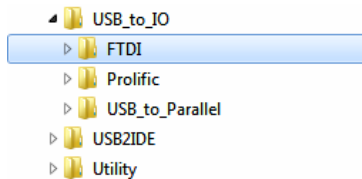

CHECK INSTALLED DRIVER

Open the **>Device manager<**. Now you should see at „**Ports (COM & LPT)**“ and at „**USB-Controller**“ the following new entry's:



If you see this or a similar information the device is installed correctly.

CHANGE PORT NUMBER

If you like to change the port number for example COM3 to COM5, open the „**Device Manager**“ click at „**COM3**“, „**Settings**“ and then „**Advance**“. There you can change between COM3 till COM256.

6. Driver Installation

Linux & Mac OS

The drivers for Linux & Mac OS systems are also in the same folder „USB_to_IO/FTDI“. Please select the folder with your operating system and install the driver (see Picture).

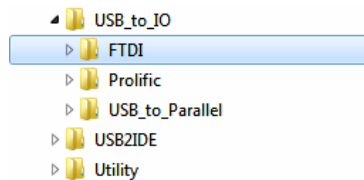

Because each individual distribution and kernel version of Linux is different, sadly we can't provide a installation instruction. Please refer to the installation manual for standard I/O ports from your Linux/Unix version! In some newer versions of Linux the card will even be installed automatically after starting Linux.

7. Technical Information

Chip-Set:	FTDI
Data Transfer Rate:	300 Baud up to 921.6 KBAud
Connectors:	2x 9 Pin serial RS-232 Connector, 1x SATA Power Connector
Hardware System:	PCI-Express x1 to x16
Operating System:	Windows 200x/ XP/ Vista/ 7/ 8.x/ 10/ Server 200xx Linux/ Mac OS
Operating Temperature:	32°F to 55°Fahrenheit
Storage Temperature:	-40°F to 167°Fahrenheit
Rel. Humidity:	5% to 95%
Power:	5V or 12V via PCI-Express Slot or SATA Power Connector
Size:	112,30 x 120,00 mm
Weight:	200g